

Owner's Manual

Ceiling Fan Installation Instructions



For 5WN52XXD Series Fan

READ AND SAVE THESE INSTRUCTIONS

Total fan weight
with lights

**MONTE
CARLO**®



Installation

SAFETY TIPS

WARNING: TO REDUCE THE RISK OF FIRE, ELECTRIC SHOCK, OR INJURY TO PERSONS, OBSERVE THE FOLLOWING: READ AND SAVE THESE INSTRUCTIONS

1. Installation work and electrical wiring must be done by qualified person(s) in accordance with applicable codes and standards (ANSI/NFPA 70-1999), including fire-rated construction.
2. Use this unit only in the manner intended by the manufacturer. If you have any questions contact the manufacturer.
3. After making the wire connections, the wires should be spread apart with the grounded conductor and the equipment-grounding conductor on one side of the outlet box and ungrounded conductor on the other side of the outlet box.
4. Before you begin installing the fan, Switch power off at Service panel and lock service disconnecting means to prevent power from being switched on accidentally. When the service disconnecting means cannot be locked, securely fasten a prominent warning device, such as a tag, to the service panel.
5. Be cautious! read all instructions and safety information before installing your new fan. Review the accompanying assembly diagrams.
6. When cutting or drilling into wall or ceiling, do not damage electrical wiring and other hidden utilities.
7. Make sure the installation site you choose allows the fan blades to rotate without any obstructions. Allow a minimum clearance of 7 feet from the floor to the trailing edge of the blade.
8. To reduce the risk of fire, electric shock, or personal injury, mount to outlet box or supporting system acceptable for fan support. (Mounting must support at least 35 lbs.)
9. Do not bend blade holders during installation to motor; balancing or during cleaning. Do not insert foreign object between rotating blades.
10. Attach the mounting bracket using only the hardware supplied with the outlet box.
11. To reduce the risk of fire or electric shock, do not use this fan with any solid state fan speed control device, or variable speed control.
12. If this unit is to be installed over a tub or shower, it must be marked as appropriate for the application.
13. NEVER place a switch where it can be reached from a tub or shower.
14. The combustion airflow needed for safe operation of fuel-burning equipment may be affected by this unit's operation. Follow the heating equipment manufacturer's guideline safety standards such as those published by the National Fire Protection Association (NFPA), and the American Society for Heating, Refrigeration and Air Conditioning Engineers (ASHRAE) and the local code authorities.
15. Before servicing or cleaning unit, Switch power off at Service panel and lock service disconnecting means to prevent power from being switched on accidentally. When the service disconnecting means cannot be locked, securely fasten a prominent warning device, such as a tag, to the service panel.
17. Warning: To avoid possible risk of fire or shock, the connectors should not be removed unless the light kit will be immediately installed and that the power should be turned off prior to the connector removal of the light kit installation.

TOOLS REQUIRED

Phillips Screwdriver

Wire Cutters

Pliers

Step Ladder



1
Before you begin installing the fan, Switch power off at Service panel and lock service disconnecting means to prevent power from being switched on accidentally. When the service disconnecting means cannot be locked, securely fasten a prominent warning device, such as a tag, to the service panel.

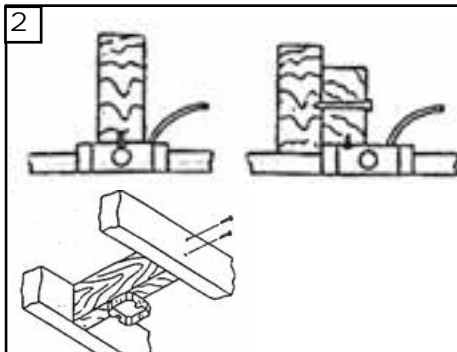

2
Before installing this fan make sure the outlet box is properly installed to the house structure. To reduce the risk of fire, electric shock, or personal injury, mount to outlet box or supporting system acceptable for fan support. (Mounting must support at least 35 lbs.)

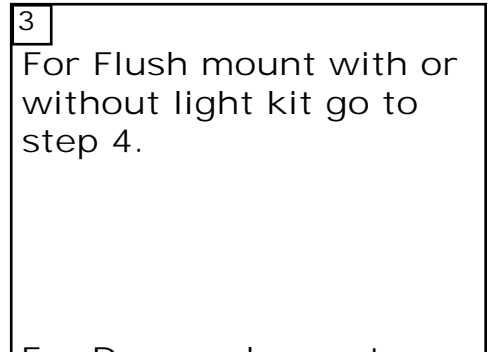

3
For Flush mount with or without light kit go to step 4.

For Downrod mount with or without light kit go to step 30.



4
Remove the coupler from the mounting plate by unscrewing 6 screws. Save the yoke and screws for future use when installing downrod.

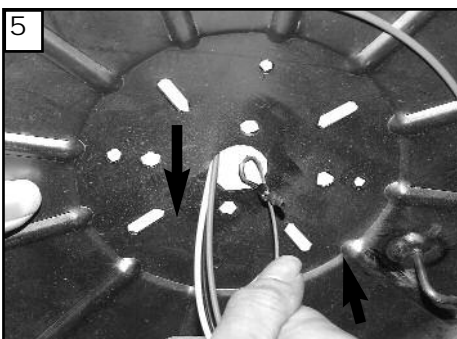

5
Thread safety cable through center hole of the mounting plate. Thread your house wires through center hole also. These will be needed for wiring of the fan.

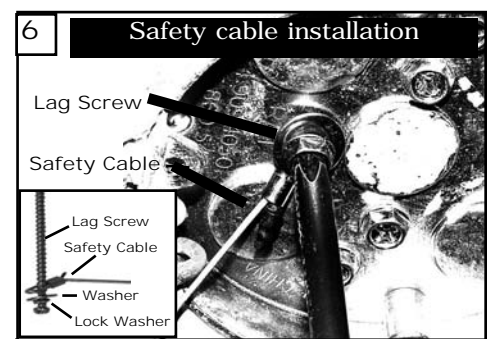

Safety cable installation

Lag Screw

Safety Cable

Washer

Lock Washer

6
For Canadian installation and for USA fan and light kit combinations over 35 lbs, in both flush and downrod mode the safety cable must be installed into the house structure beams using the 3" lag screws provided. Make sure that when the safety cable is fully extended the leadwires are longer than the cable and no stress is placed on the leadwires.

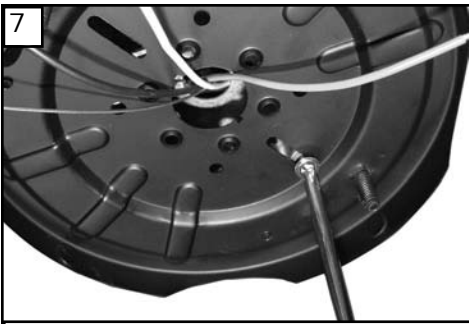

Securely attached the mounting plate to the outlet box using two screws supplied by the outlet box. Use metal outlet box suitable for fan support (must support 35 lbs).

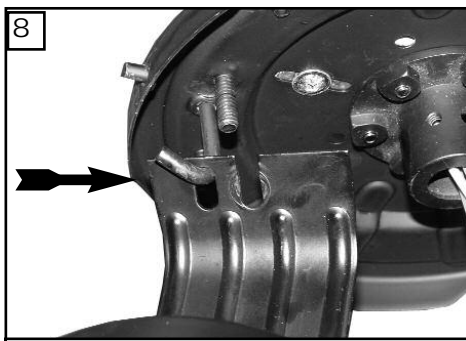

Carefully lift the fan motor assembly and engage the slot in the motor bracket with the hook on the mounting plate so that the motor is securely suspended.

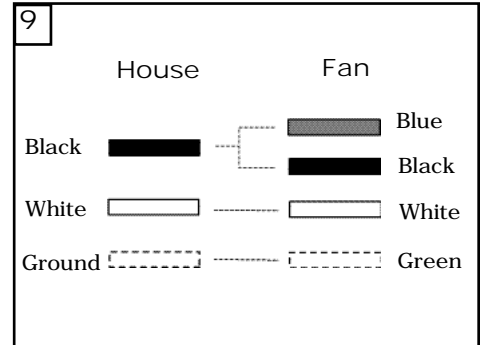

Connect black and blue wire from fan to Black or (Hot) wire from house. Connect White wire from Fan to White (Neutral) wire from house. Connect Ground leads from mounting bracket and downrod to Ground lead from house. Refer to Safety Tips section of manual.



Make wire connections to power source using wire nuts provided. Make sure that no filaments are outside of the wirenut. After making the wire connections, the wires should be spread apart with the grounded conductor and the equipment-grounding conductor on one side of the outlet box and ungrounded conductor on the other side of the outlet box.



Lift the motor bracket so that the threaded studs on the mounting plate protrude through the slots in the motor bracket. Securely tighten the locknuts onto the threaded studs.

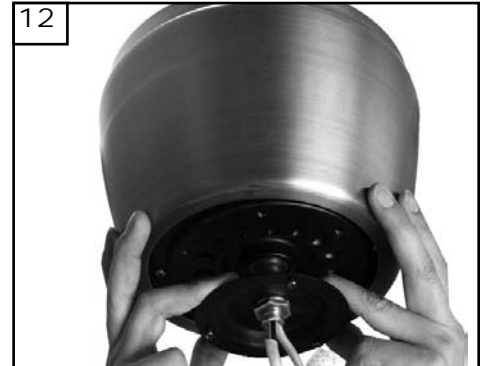

Lift housing up and turn housing clockwise to hold in position.



Attach blade to blade bracket using the screws and washers provided. Tighten each of the screws securely. Repeat this process 4 more times.

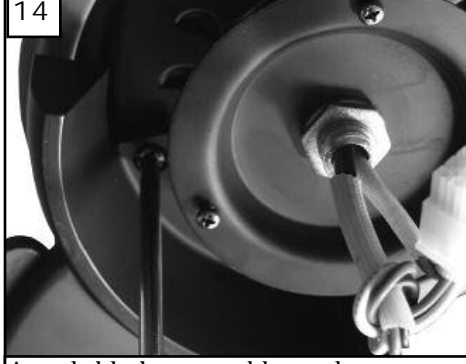

Attach blade assembly to the motor and tighten screws securely. Repeat this process 4 more times.



Loosen 2 screws and remove 1 screw from motor plate and save.

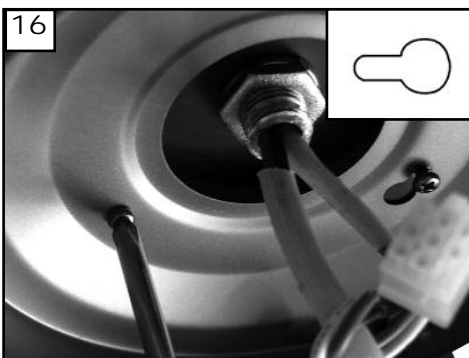

Align keyslot holes and twist to lock. Add the screw removed from step 15. Tighten securely.

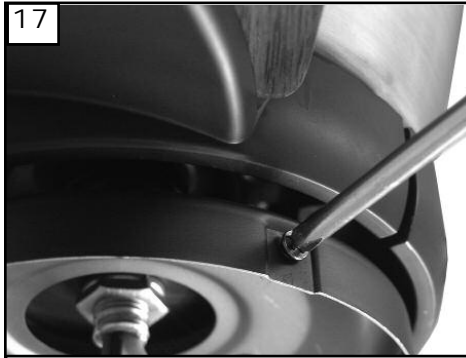

Remove 3 screws from switch cap plate. Save the screws for future use.

For fan with light kit go to step 18.
For fan without light kit go to step 24.

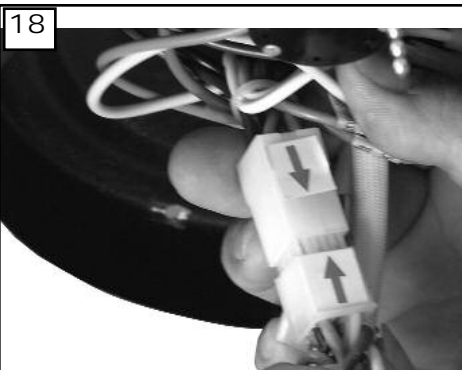

18
Connect 9 pin connector from the fan to the 9 pin connector from the light kit.

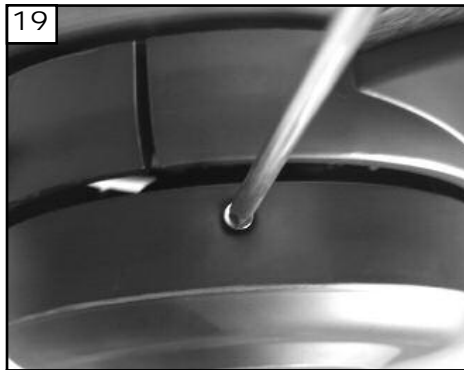

19
Install switch cap with fitter onto fan using 3 screws removed in earlier step and tighten securely.

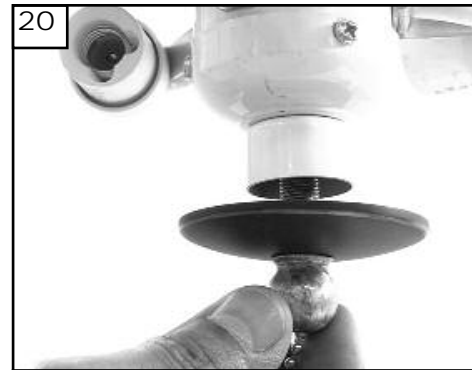

20
Remove the finial, finial cap, rubber washer, hex-nut from fitter.



21
Install 3 X 40 watt candelabra bulbs. Bulbs are NOT included.



22
Place glass on fitter, and then install rubber washer and hex-nut.



23
Install finial cap and finial nut, securely tighten.

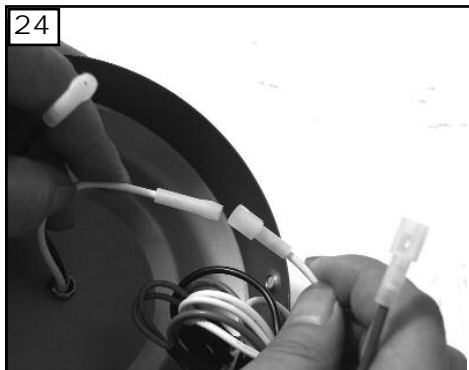

24
Disconnect the two plugs to take the capacitor assembly out, white wire from the white wire, the black wire from the blue wire.



25
Remove the hex-nut and switch cap from fitter.

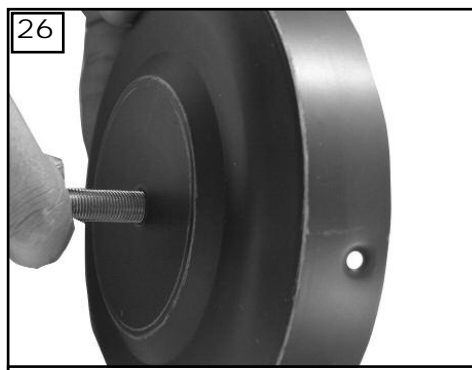

26
Install stud (provided in hardware) to the center hole of the switch cap. Install internal lockwasher and hex-nut to internal parts of the stud.

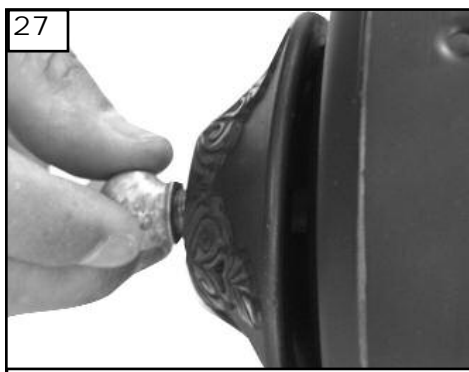

27
Install the decorative cap and finial nut onto the switch cap and tighten securely.

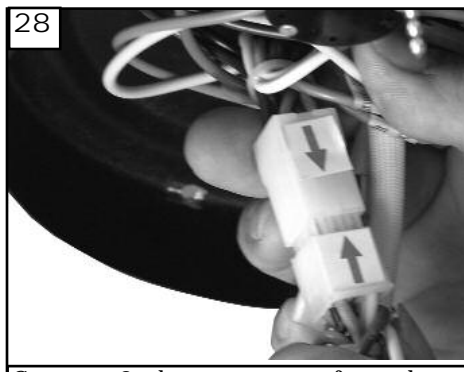

28
Connect 9 pin connector from the fan to the 9 pin connector from the light kit.

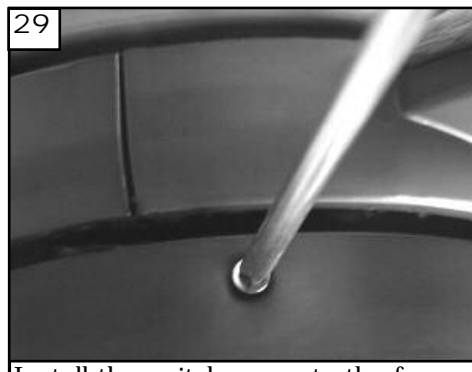

29
Install the switch cap onto the fan with 3 screws removed from an earlier step and tighten securely.



30 Use metal outlet box suitable for fan support and use only the screws provided with the outlet box (must support 35 lbs). Before attaching fan to outlet box, ensure the outlet box is securely fastened by at least two points to a structural ceiling member (a loose box will cause the fan to wobble). Remove the two outlet box screws provided with the box, aligning the holes of the mounting bracket with the holes of the outlet box. Re-install the 2 outlet box screws securely.

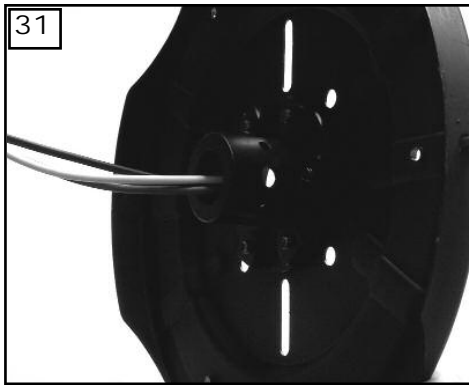

31 Thread leadwires and safety cable through the mounting plate.

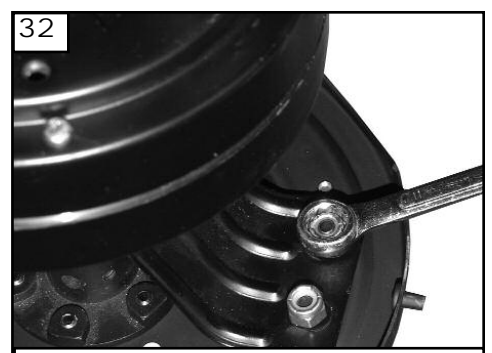

32 The studs on the mounting plate protrude through the slots in the motor bracket. Securely tighten the lock-nuts onto the threaded studs.

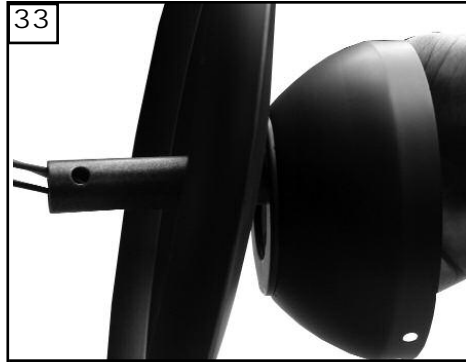

33 Thread leadwires and safety cable through the housing decorative cover the canopy and downrod.



34 Loosen the 2 set screws in yoke.

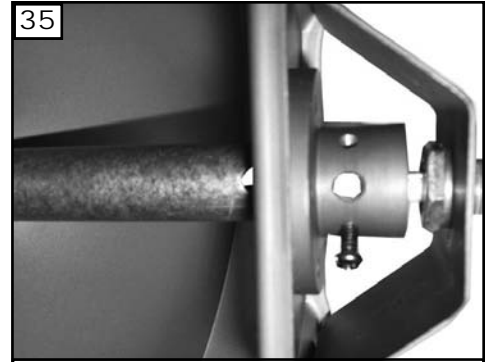

35 Insert downrod into yoke. Align the hole in the downrod with hole in the yoke.

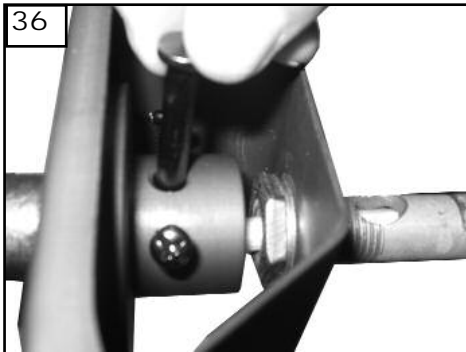

36 Insert the pin through the yoke and downrod until the point appears on the other side.

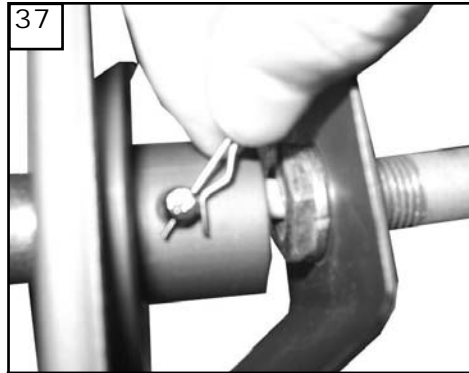

37 Install the keeper to pin.

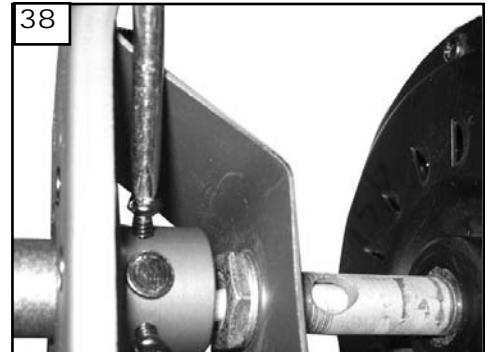

38 Tighten the 2 set screws on the yoke once the downrod is in place.

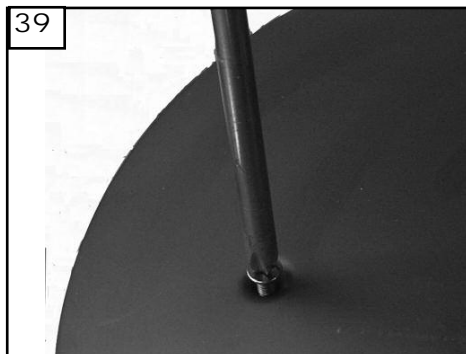

39 Install motor housing cover to the mounting plate with 3 screws.



40 Lift housing up and turn housing clockwise to hold in position.

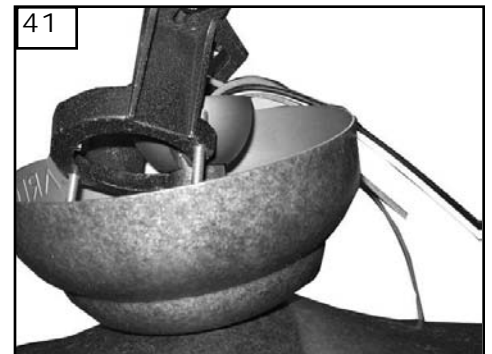

41 Hang assembled fan to the mounting bracket installed to ceiling in previous step.



Fan and light kit combinations over 35 lbs, in both flush and downrod mode the safety cable must be installed into the house structure beams using the 3" lag screws, washers, and lock washers, provided. Make sure that when the safety cable is fully extended the leadwires are longer than the cable and no stress is placed on the leadwires.

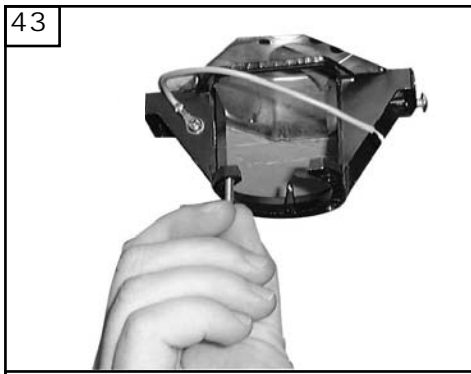

Make sure the studs protruding from the bottom of the mounting bracket are installed with threads all the way through the bracket.

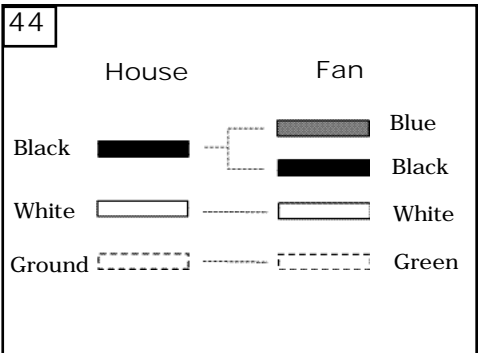

Connect black and blue wire from fan to Black or (Hot) wire from house. Connect White wire from Fan to White (Neutral) wire from house. Connect Ground leads from mounting bracket and downrod to Ground lead from house. Refer to Safety Tips section of manual.



Make wire connections to power source using wire nuts provided. Make sure that no filiments are outside of the wirenut. After making the wire connections, the wires should be spread apart with the grounded conductor and the equipment-grounding conductor on one side of the outlet box and ungrounded conductor on the other side of the outlet box.



Lift canopy up aligning with the studs from mounting bracket. Install the 2 thumb nuts to the studs and finger tighten.

47

Go to step 13 to finish installation.

Trouble Shooting

If you have difficulty operating your new ceiling fan, it may be the result of incorrect assembly, installation, or wiring. In some cases, these installation errors may be mistaken for defects. If you experience any faults, please check this Trouble Shooting Chart. If a problem cannot be remedied, or you are experiencing difficulty in installation, please call our Customer Service Center at the number printed on your parts list insert sheet. **Warning:** Before servicing or cleaning unit, Switch power off at Service panel and lock service disconnecting means to prevent power from being switched on accidentally. When the service disconnecting means cannot be locked, securely fasten a prominent warning device, such as a tag, to the service panel.

Trouble	Suggested Remedy
1. If fan does not start:	<ol style="list-style-type: none">1. Check main and branch circuit fuses or circuit breakers.2. Check line wire connections to fan and switch wire connections in switch housing.3. Check to make sure the dip switches from the transmitter and receiver are set on the same frequency. <p>CAUTION: Make sure main power is turned off</p>
2. If fan sounds noisy:	<ol style="list-style-type: none">1. Check to make sure all screws in motor housing are snug (not over tightened).2. Check to make sure the screws which attach the fan blade holder to the motor are tight.3. Check to make sure wire nut connectors in switch housing are not rattling against each other or against the interior wall of the switch housing. <p>CAUTION: Make sure main power is turned off before entering switch housing.</p> <ol style="list-style-type: none">4. Some fan motors are sensitive to signals from Solid State variable speed controls. DO NOT USE a Solid State variable speed control.5. Allow "break-in" period of 24 hours. Most noises associated with a new fan will disappear after this period.
3. If fan wobbles:	<ol style="list-style-type: none">1. Make sure that the ridge of the canopy engages the notch in the downrod ball.2. Check that all blades are screwed firmly into blade holders.3. Check that all blade holders are tightened securely to motor.4. Make sure that canopy and mounting bracket are tightened securely to ceiling junction box and junction box is mounted firmly to ceiling joist.5. Most fan wobble problems are caused when blade levels are unequal. Check this level by selecting a point on the ceiling above the tip of one of the blades. Measure this distance from blade tip to ceiling. Keeping measure within 1/8", rotate the fan until the next blade is positioned for measurement. Repeat for each blade. If all blade levels are not equal, you can adjust blade levels by the following procedure. To adjust a blade tip down, insert a washer (not supplied) between the blade and blade holder at the screw closest to the motor. To adjust a blade tip up, insert washer (not supplied) between the blade and blade holder at the two screws farthest from the motor. Reverse the position of the washer if blades mount from top of blade.6. If blade wobble is still noticeable, interchanging two adjacent (side by side) blades can redistribute the weight and possibly result in smoother operation.
4. If light does not work:	<ol style="list-style-type: none">1. Check wire from fan to make sure it is connected to hot wire from house.2. Check for loose or disconnected wires in fan switch housing.3. Check for loose or disconnected wires in light kit.4. Check for faulty light bulbs. <p>CAUTION: Make sure main power is turned off before entering switch housing.</p>

MONTE CARLO®

Customer Service Center:
301 West Washington St.
Riverside, NJ 08075
1-800-519-4092
www.montecarlofans.com