

OWNER'S MANUAL

Ceiling Fan Installation Instructions

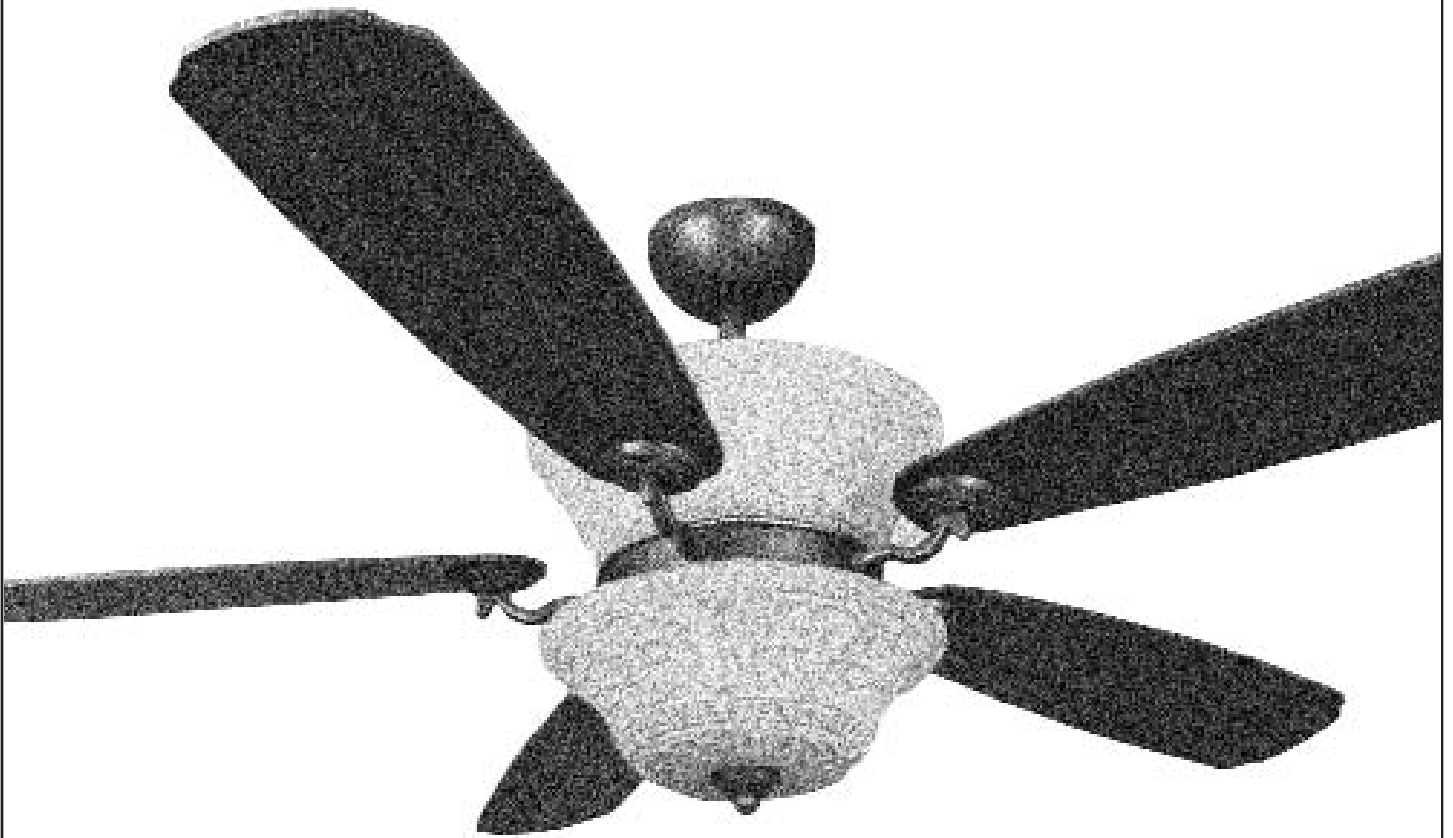

For 5LPR52XXD Series Fans

READ AND SAVE THESE INSTRUCTIONS

**MONTE
CARLO**

Total fan weight



Installation

SAFETY TIPS

WARNING: TO REDUCE THE RISK OF FIRE, ELECTRIC SHOCK, OR INJURY TO PERSONS, OBSERVE THE FOLLOWING: READ AND SAVE THESE INSTRUCTIONS

1. Installation work and electrical wiring must be done by qualified person(s) in accordance with applicable codes ANSI/NFPA 70-1999), including fire-rated construction.
2. Use this unit only in the manner intended by the manufacturer. If you have any questions contact the manufacturer.
3. After making the wire connections, the wires should be spread apart with the grounded conductor and the equipment-grounding conductor on one side of the outlet box and ungrounded conductor on the other side of the outlet box.
4. Before you begin installing the fan, Switch power off at Service panel and lock service disconnecting means to prevent power from being switched on accidentally. When the service disconnecting means cannot be locked, securely fasten a prominent warning device, such as a tag, to the service panel.
5. Be cautious! read all instructions and safety information before installing your new fan. Review the accompanying assembly diagrams.
6. When cutting or drilling into wall or ceiling, do not damage electrical wiring and other hidden utilities.
7. Make sure the installation site you choose allows the fan blades to rotate without any obstructions. Allow a minimum clearance of 7 feet from the floor to the trailing edge of the blade.
8. To reduce the risk of fire, electric shock, or personal injury, mount to outlet box or supporting system acceptable for fan support and use only the screws provided with the outlet box. (Mounting must support at least 35 lbs.)
9. Do not bend blade holders during installation to motor, balancing or during cleaning. Do not insert foreign object between rotating blades.
10. Attach the mounting bracket using only the hardware supplied with the outlet box.
11. Suitable for use with solid-state speed controls
12. The combustion airflow needed for safe operation of fuel-burning equipment may be affected by this unit's operation. Follow the heating equipment manufacturer's guideline safety standards such as those published by the National Fire Protection Association (NFPA), and the American Society for Heating, Refrigeration and Air Conditioning Engineers (ASHRAE) and the local code authorities.
13. Before servicing or cleaning unit, Switch power off at Service panel and lock service disconnecting means to prevent power from being switched on accidentally. When the service disconnecting means cannot be locked, securely fasten a prominent warning device, such as a tag, to the service panel.
14. Airflowdirection: warm weather-switch to left - forward / cool weather -switch to right - reverse
15. All screws must be checked and Retightened where necessary before installation
16. **WARNING-To Reduce The Risk Of Electric Shock, This Fan Must Be Installed With An Isolating Wall Control/Switch.**
17. Risk of fire, electric shock, or injury to persons, for cleaning and user- maintenance.
18. The safety device is to be reinstalled or remounted as previously installed.
19. Instructions for supply connections: conductor of a fan identified as grounded conductor to be connected to a ground conductor of power supply, conductor of fan identified as ungrounded conductor to be connected to an ungrounded conductor of power supply, conductor of fan identified for equipment ground- ing to be connected to an equipment-grounding conductor.

TOOLS REQUIRED

Phillips Screwdriver

Wire Cutters

Pliers

Step Ladder



1 Before you begin installing the fan, Switch power off at Service panel and lock service disconnecting means to prevent power from being switched on accidentally. When the service disconnecting means cannot be locked, securely fasten a prominent warning device, such as a tag, to the service panel.

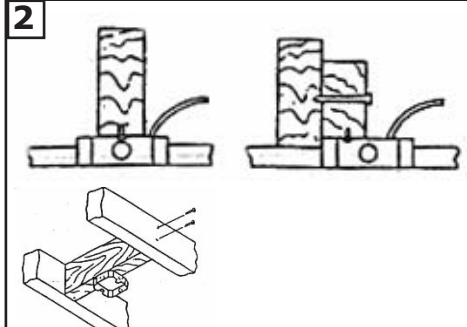

2 Before installing this fan make sure the outlet box is properly installed to the house structure. To reduce the risk of fire, electric shock, or personal injury, mount to outlet box or supporting system acceptable for fan support. (Mounting must support at least 35 lbs.)



3 Use metal outlet box suitable for fan support and use only the screws provided with the outlet box (must support 35 lbs). Before attaching fan to outlet box, ensure the outlet box is securely fastened by at least two points to a structural ceiling member (a loose box will cause the fan to wobble). **Use only the screws provided with the outlet box.** Remove the two outlet box screws provided with the box, aligning the holes of the mounting bracket with the holes of the outlet box. Re-install the 2 outlet box screws securely.

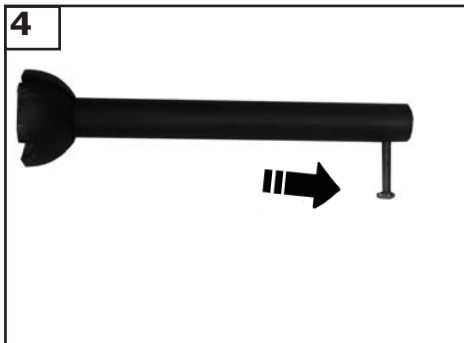

4 Remove the cotter and keeper pins and save for later use.

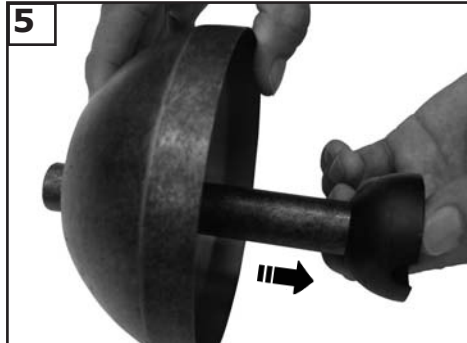

5 Place canopy on downrod. (as shown)

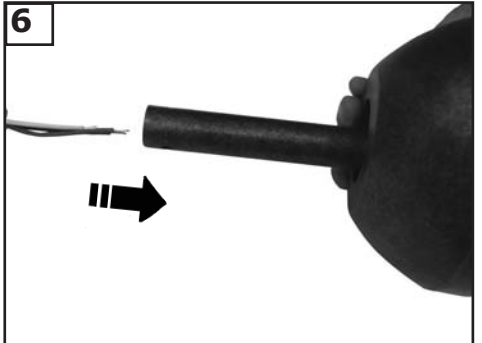

6 Thread leadwires and safety cable through downrod. (as shown)

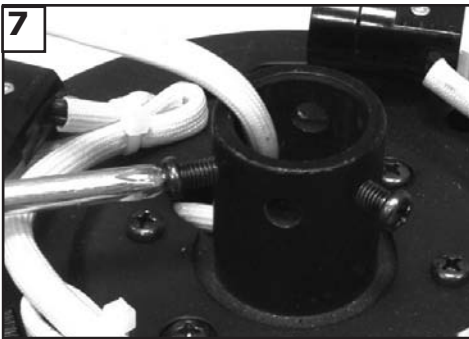

Loosen the 2 set screws in yoke for downrod to slip into yoke.

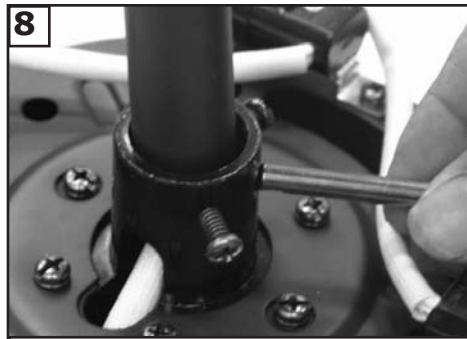

Insert downrod into yoke on top of the Fan Body. Align the hole in the Downrod with the hole in the Yoke. Insert the Pin through the Yoke and Downrod until the point appears on the other side.

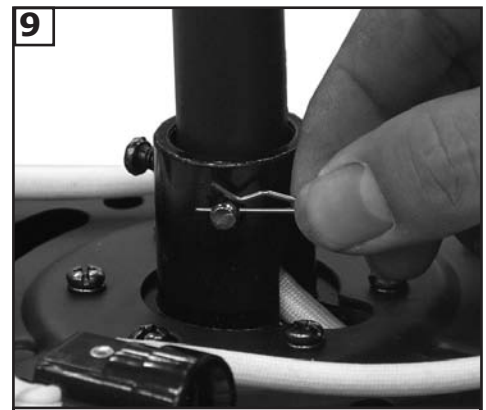

Install the Keeper Pin

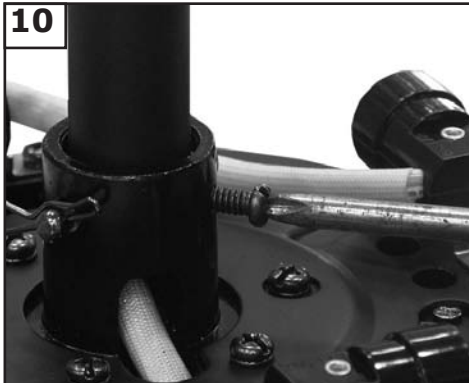

Tighten the 2 set screws on yoke once the downrod is installed in place.

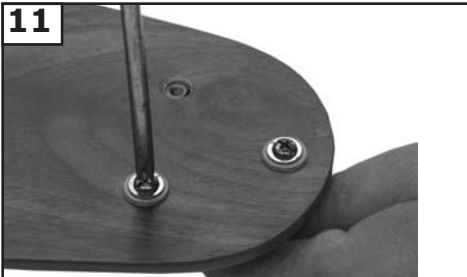

Place blade bracket onto blades aligning holes in blade bracket with holes in blade. Make sure the side of the blade you select is facing downward. Install 3 screws and washers to back side of blade as shown. Tighten screws securely. Repeat this process 4 more times.



Remove 2 cardboards pre-installed to the fan body. Rotate the center flywheel so that the hole in the flywheel is facing opening of the upper light kit plate. Insert the blade/blade bracket assembly into the flywheel hole and tighten the screws securely. Repeat 4 more times.

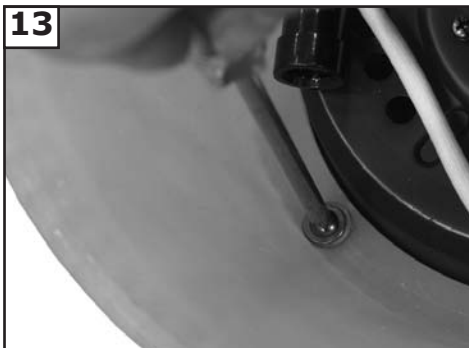

Remove and keep the 4 screws and fiber washers pre-attached. Install the upper glass with screws and fiber washers securely.



Install 4 x 15 watt candelabra base bulbs included.



Hang assembled fan from the mounting bracket installed to ceiling in previous step. Make sure the fan is hanging straight. Rotate fan until the tab on the Mounting bracket engages the slot on the Downrod Ball. This must be done to prevent the fan body from rotating when the blades are in motion.



16 Safety cable installation
For Canadian installation in both flush and down-rod mode the safety cable must be installed into the house structure beams using the 3" lag screws provided. Make sure that when the safety cable is fully extended the leadwires are longer than the cable and no stress is placed on the leadwires.

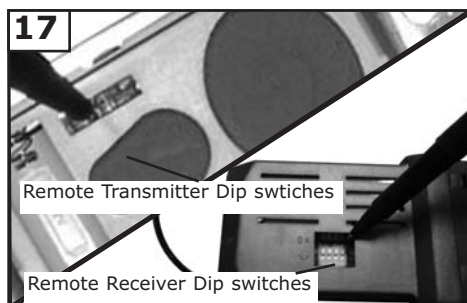

17
Set dip switches on the Remote Transmitter and Remote Receiver to the same settings. This must be done so the units will communicate properly. If you have other fans you can set to control from one transmitter by setting both receivers the same as the transmitter. If you have more than one fan with remote. You can set the dip switches to different positions to have separate control.



18
Install remote receiver into mounting bracket.

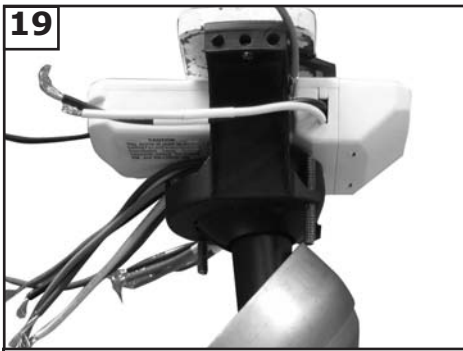

Ready for wiring

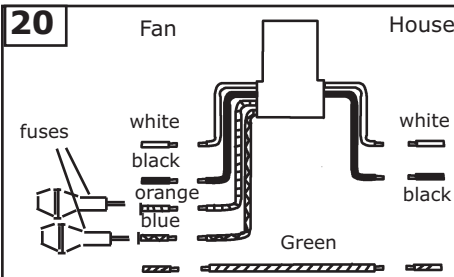

Make wiring connections as indicated above. White from fan to white from remote marked N. Orange from fan to Orange from remote marked Light/up. Blue from fan to blue from remote marked down light. Black from fan to Black from remote marked L. White from house to white from remote marked AC N . Black from house to Black from remote marked AC L. Connect all green ground wires to Ground wire from House.



Make wire connections to power source using wire nuts provided. Make sure that no filaments are outside of the wirenut. After making the wire connections, the wires should be spread apart with the grounded conductor and the equipment-grounding conductor on one side of the outlet box and ungrounded conductor on the other side of the outlet box. The splices after being made should be turned upward and pushed carefully up into the outlet box.



Lift canopy allowing the 2 studs to protrude through the canopy and install knurled nuts as shown. Tighten the knurled nuts securely.

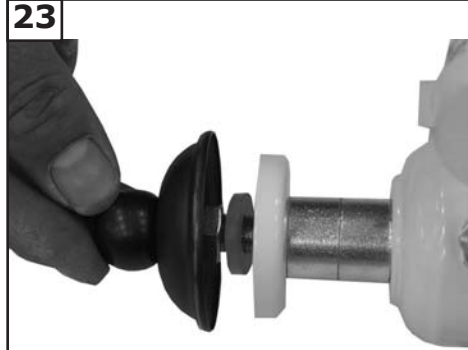

Remove the finial cap, finial nut hex-nut and rubber washer from the fitter.



Remove three screws and washers from light fitter.



Connect white wire from fan to white wire from light fixture. Then plug blue wire from fan to black wire from light fixture.

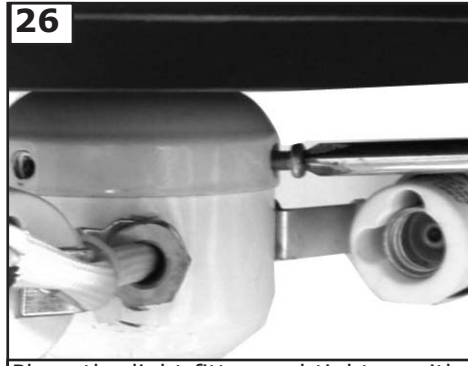

Place the light fitter and tighten with screws and washers.

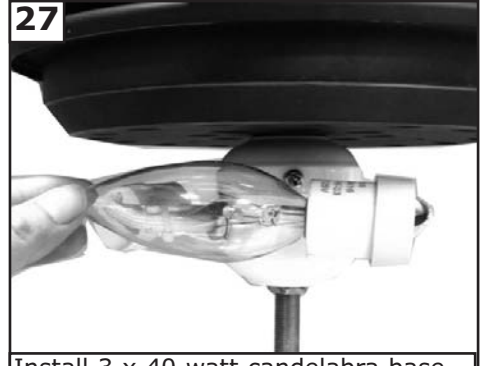

Install 3 x 40 watt candelabra base bulbs. Bulbs not included.



Place glass on fitter.



Place hex-nut and rubber washer on fitter, tighten securely, and then place the finial cap over the threaded rod and tighten the finial nut securely by hand.



Reverse function for this fan is a switch on the top housing of the fan body. Turn fan off and wait for fan to stop then flip the switch to reverse the direction of the blades.

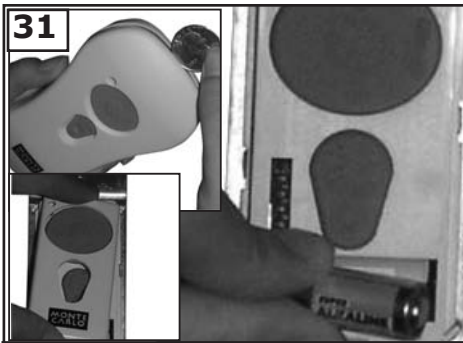

31
Remove cover by snapping off from top or bottom. Remove battery cover. Install 12V battery into wall remote. Duracell MN21 / Eveready A23 / GP 23A all 12V. Attach cover of remote by placing over buttons and snap the battery cover in place.

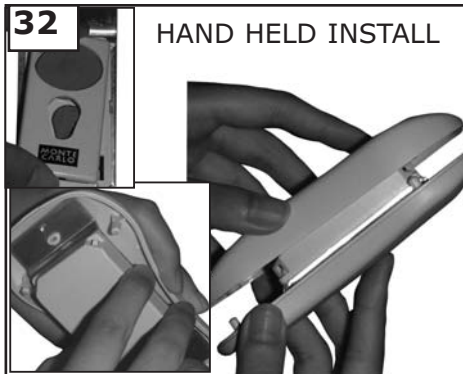

32 HAND HELD INSTALL
Place face plate over battery compartment and buttons. Place remote over 2 pins on front cover. Attach cover of remote by placing over 4 pins and snapping into place.

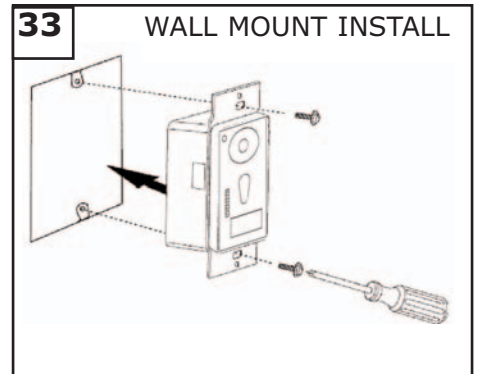

33 WALL MOUNT INSTALL
Install wall control unit to outlet box using machine screws provided.

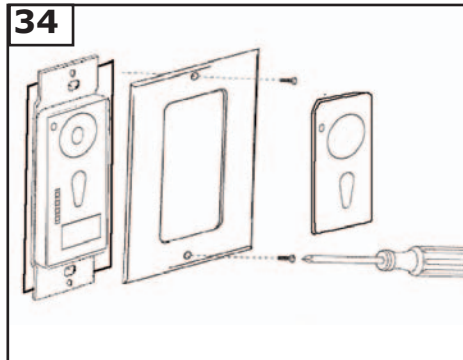

34
Attach front cover to wall control with screws provided. Snap battery cover in place.

Remote Control Transmitter Features:

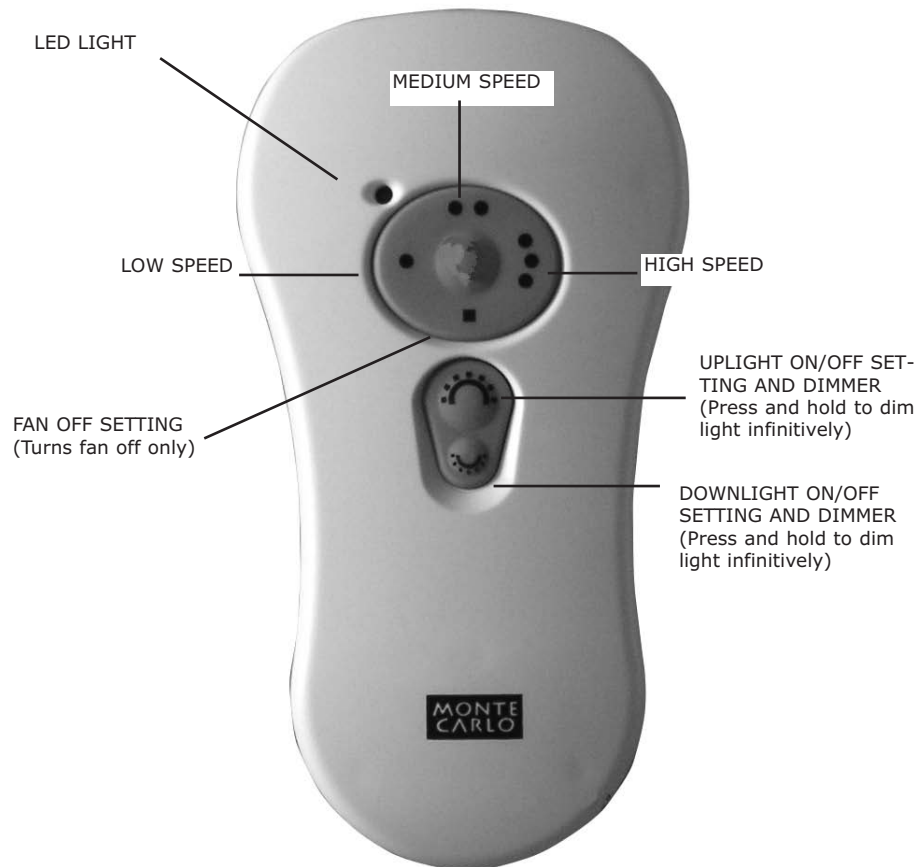

FAN SPEED Depress "1 dot" for low speed, "2 dots" for medium or "3 dots" for high. To turn fan off press square".

LIGHT DIMMER To turn light on, press light dimmer once quickly. To turn off press once quickly while light is on. To dim light hold down button "light dimmer". The light will cycle from bright to dim to bright until button is released. Light will maintain last setting if turned off.

TROUBLE SHOOTING

If you have difficulty operating your new ceiling fan, it may be the result of incorrect assembly, installation, or wiring. In some cases, these installation errors may be mistaken for defects. If you experience any faults, please check this Trouble Shooting Chart. If a problem cannot be remedied, or you are experiencing difficulty in installation, please call our Customer Service Center at the number printed on your parts list insert sheet.

Warning: Before servicing or cleaning unit, Switch power off at Service panel and lock service disconnecting means to prevent power from being switched on accidentally. When the service disconnecting means cannot be locked, securely fasten a prominent warning device, such as a tag, to the service panel.

Trouble	Suggested Remedy
1. If fan does not start:	<ol style="list-style-type: none">1. Check main and branch circuit fuses or circuit breakers.2. Check line wire connections to fan and switch wire connections in switch housing. <p>CAUTION: Make sure main power is turned off.</p> <ol style="list-style-type: none">3. Make sure forward/reverse switch is firmly in up or down position. Fan will not operate when switch is in the middle.4. Make sure that shipping stabilizer tabs have been removed from motor.
2. If fan sounds noisy:	<ol style="list-style-type: none">1. Check to make sure all screws in motor housing are snug (not over tightened).2. Check to make sure the screws which attach the fan blade holder to the motor are tight.3. Check to make sure wire nut connectors in switch housing are not rattling against each other or against the interior wall of the switch housing. <p>CAUTION: Make sure main power is turned off before entering switch housing or canopy.</p> <ol style="list-style-type: none">4. If using an optional Ceiling Fan Light Kit, check to be sure the screws securing the glassware are finger tight. Check to be sure light bulb is tight in socket and not touching glass shade(s). If vibration persists from glass, remove glass and install a 1/4" wide rubber band on glass neck to act as an insulator. Replace glass and tighten screws against rubber band.5. Some fan motors are sensitive to signals from Solid State variable speed controls.6. Allow "break-in" period of 24 hours. Most noises associated with a new fan will disappear after this period.
3. If fan wobbles:	<ol style="list-style-type: none">1. Make sure that the ridge of the canopy engages the notch in the downrod ball. (See illustration in Step #6 of Downrod Mount installation).2. Check that all blades are screwed firmly into blade holders.3. Check that all blade holders are tightened securely to motor.4. Make sure that canopy and mounting bracket are tightened securely to ceiling junction box and junction box is mounted firmly to ceiling joist.5. Most fan wobble problems are caused when blade levels are unequal. Check this level by selecting a point on the ceiling above the tip of one of the blades. Measure this distance from blade tip to ceiling. Keeping measure within 1/8", rotate the fan until the next blade is positioned for measurement. Repeat for each blade. If all blade levels are not equal, you can adjust blade levels by the following procedure. To adjust a blade tip down, insert a washer (not supplied) between the blade and blade holder at the screw closest to the motor. To adjust a blade tip up, insert washer (not supplied) between the blade and blade holder at the two screws farthest from the motor. Reverse the position of the washer if blades mount from top of blade.6. If blade wobble is still noticeable, interchanging two adjacent (side by side) blades can redistribute the weight and possibly result in smoother operation.
4. If light does not work:	<ol style="list-style-type: none">1. Check blue wire from fan to make sure it is connected to hot wire from house.2. Check for loose or disconnected wires in fan switch housing.3. Check for loose or disconnected wires in light kit.4. Check for faulty light bulbs. <p>CAUTION: Make sure main power is turned off before entering switch housing or canopy.</p>

User Servicing Instructions

WARNING: Before attempting to replace the fuse make sure the main power is turned off to the fan. (Fuse is inside the canopy on the blue and orange wires to remote receiver, push and twist the cap to open the fuse case) Push and twist to reassemble fuse. Risk of fire. Replace fuse only with 3 amp, 125 volt fuse.

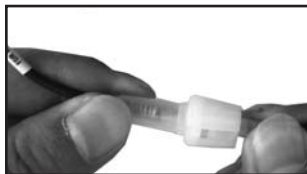

MONTE CARLO
Customer Service Center:
301 West Washington St.
Riverside, NJ 08075
1-800-519-4092
www.montecarlofans.com