

# Owner's Manual

## Ceiling Fan Installation Instructions

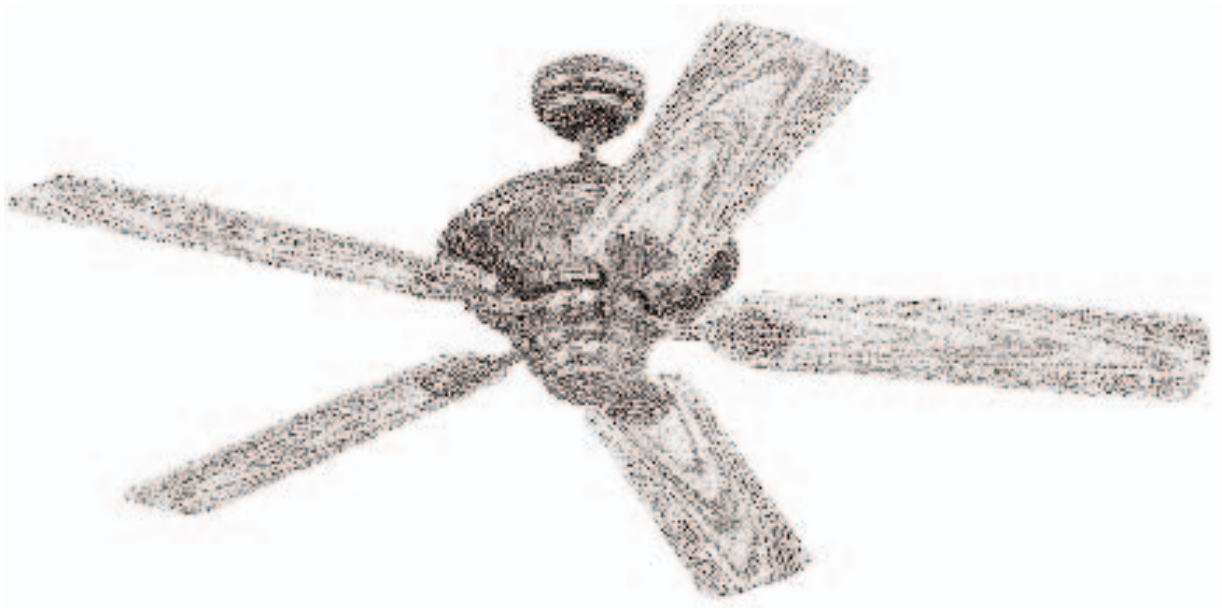

Total fan weight

**For 5CZ52 Series Fans**

**READ AND SAVE THESE INSTRUCTIONS**



**MONTE CARLO**  
Quality Ceiling fans



# Installation

## SAFETY TIPS

WARNING: TO REDUCE THE RISK OF FIRE, ELECTRIC SHOCK, OR INJURY TO PERSONS, OBSERVE THE FOLLOWING: READ AND SAVE THESE INSTRUCTIONS

1. Installation work and electrical wiring must be done by qualified person(s) in accordance with applicable codes and standards (ANSI/NFPA 70-1999), including fire-rated construction.
2. Use this unit only in the manner intended by the manufacturer. If you have any questions contact the manufacturer.
3. After making the wire connections, the wires should be spread apart with the grounded conductor and the equipment-grounding conductor on one side of the outlet box and ungrounded conductor on the other side of the outlet box.
4. Before you begin installing the fan, Switch power off at Service panel and lock service disconnecting means to prevent power from being switched on accidentally. When the service disconnecting means cannot be locked, securely fasten a prominent warning device, such as a tag, to the service panel.
5. Be cautious! read all instructions and safety information before installing your new fan. Review the accompanying assembly diagrams.
6. When cutting or drilling into wall or ceiling, do not damage electrical wiring and other hidden utilities.
7. Make sure the installation site you choose allows the fan blades to rotate without any obstructions. Allow a minimum clearance of 7 feet from the floor to the trailing edge of the blade.
8. To reduce the risk of fire, electric shock, or personal injury, mount to outlet box or supporting system acceptable for fan support. (Mounting must support at least 35 lbs.)
9. Do not bend blade holders during installation to motor, balancing or during cleaning. Do not insert foreign object between rotating blades.
10. Attach the mounting bracket using only the hardware supplied with the outlet box.
11. To reduce the risk of fire or electric shock, do not use this fan with any solid state fan speed control device, or variable speed control.
12. If this unit is to be installed over a tub or shower, it must be marked as appropriate for the application.
13. NEVER place a switch where it can be reached from a tub or shower.
14. The combustion airflow needed for safe operation of fuel-burning equipment may be affected by this unit's operation. Follow the heating equipment manufacturer's guideline safety standards such as those published by the National Fire Protection Association (NFPA), and the American Society for Heating, Refrigeration and Air Conditioning Engineers (ASHRAE) and the local code authorities.
15. Before servicing or cleaning unit, Switch power off at Service panel and lock service disconnecting means to prevent power from being switched on accidentally. When the service disconnecting means cannot be locked, securely fasten a prominent warning device, such as a tag, to the service panel.

**Note--For Outdoor Fans Only:** Suitable for use in wet locations when installed in a GFCI protected branch circuit.  
**Use only with light kits marked suitable for use in wet locations.**

## TOOLS REQUIRED

Phillips Screwdriver

Wire Cutters

Pliers

Step Ladder



**1** Before you begin installing the fan, Switch power off at Service panel and lock service disconnecting means to prevent power from being switched on accidentally. When the service disconnecting means cannot be locked, securely fasten a prominent warning device, such as a tag, to the service panel.

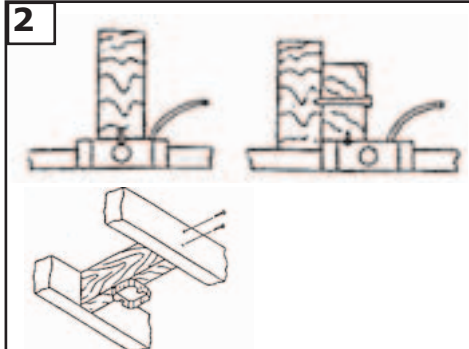

**2** Before installing this fan make sure the outlet box is properly installed to the house structure. To reduce the risk of fire, electric shock, or personal injury, mount to outlet box or supporting system acceptable for fan support. (Mounting must support at least 35 lbs.)

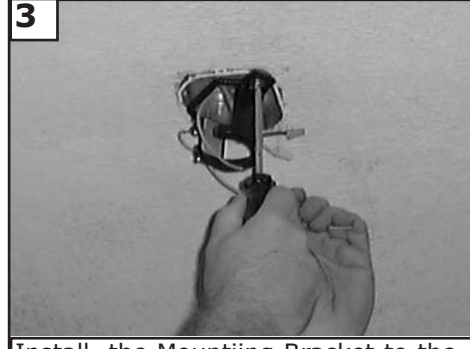

**3** Install the Mounting Bracket to the Outlet box. **Use only the screws provided with the outlet box.**

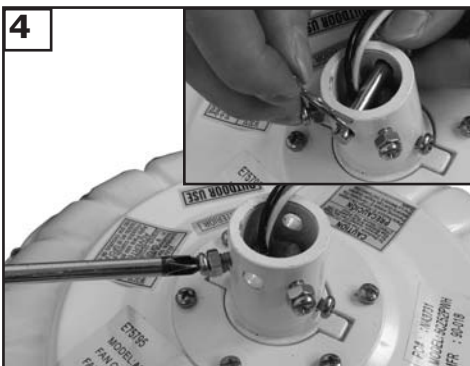

**4** Remove keeper from pin. (see inset) Loosen the 2 set screws in yoke for downrod to slip into yoke.

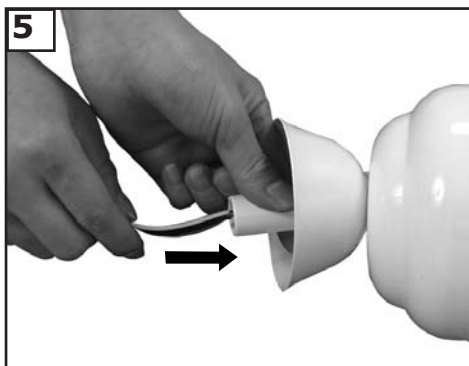

**5** Thread wires and safety cable through downrod with canopy and yoke cover assembled.



**6** Insert downrod into motor yoke. Next, insert clevis pin through yoke and downrod and secure with cotter pin. (see inset)

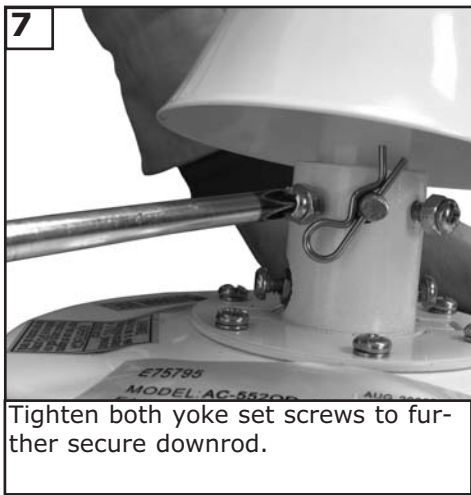

**7** Tighten both yoke set screws to further secure downrod.



**8** Carefully lift fan assembly onto mounting bracket. Rotate fan so that the notch on the ball engages the ridge in the mounting bracket. This will allow hands-free wiring.

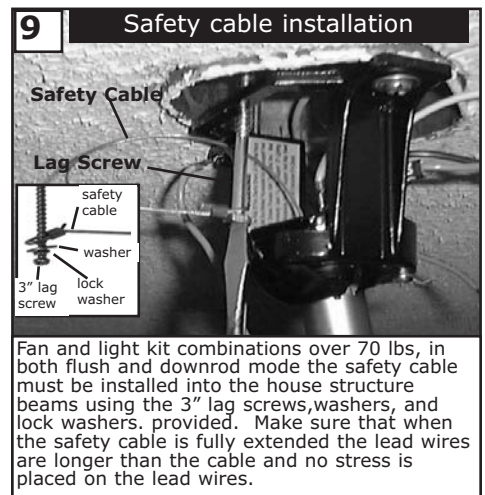

**9** Fan and light kit combinations over 70 lbs, in both flush and downrod mode the safety cable must be installed into the house structure beams using the 3" lag screws, washers, and lock washers provided. Make sure that when the safety cable is fully extended the lead wires are longer than the cable and no stress is placed on the lead wires.



**10** Make wire connections to power source using wire nuts provided. Make sure that no filaments are outside of the wirenut. After making the wire connections, the wires should be spread apart with the grounded conductor and the equipment-grounding conductor on one side of the outlet box and ungrounded conductor on the other side of the outlet box.

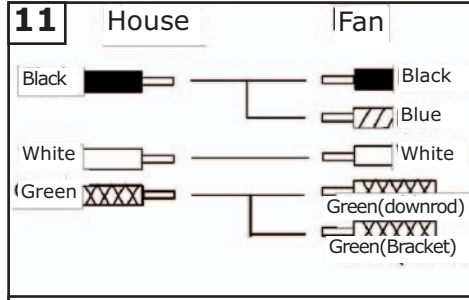

**11** For pullchain controls, follow diagram above. Make sure that all exposed wiring is secured inside wire nuts. Note: Wires from house may vary in color and may not include ground wire. After wiring is complete, gently push wires into junction box with wire nuts pointing upward. Refer to point 3 of safety tips.

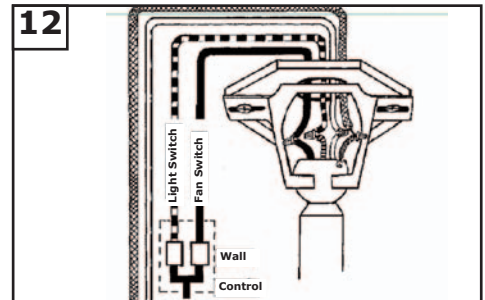

**12** For control of fan and optional light from wall location, follow diagram above. NOTE: A professional electrician is recommended for this type of installation.



**13** Raise the canopy up and align the two holes in the canopy with the two holes in the hanger bracket. Secure with two screws provided.

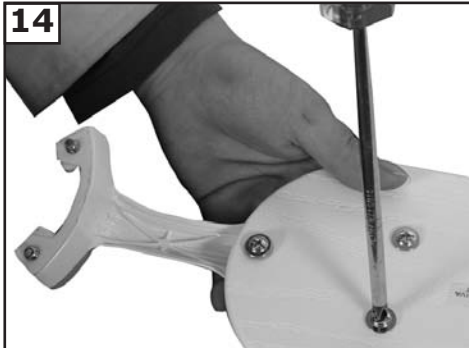

**14** Install 3 screws and washers per blade and tighten securely. Repeat for all 5 blades



**15** Check the motor for plastic shipping stabilizer tabs, and remove them if they are present.

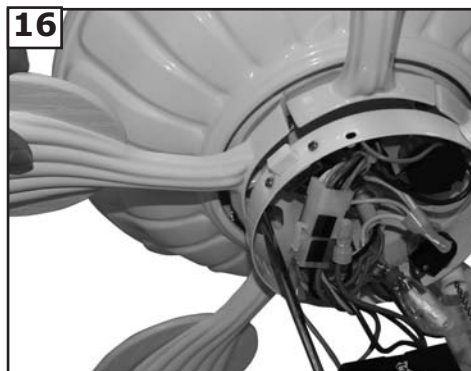

**16** Attach blade assembly to motor using the motor screws and washers provided. Tighten screws securely.



**17** After installation of all blades you must replace the rubber grommet to ensure no water leakage through to switch housing.

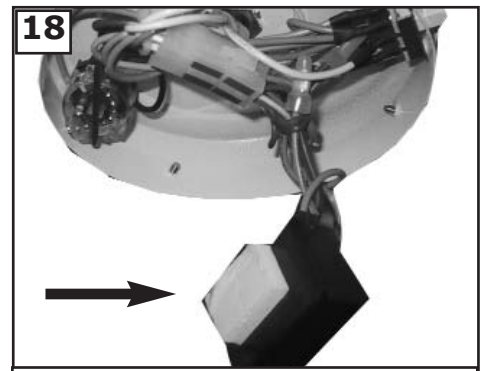

**18** Black capacitor box needs to be stuck to the switch housing. Not being attached can cause motor noise.

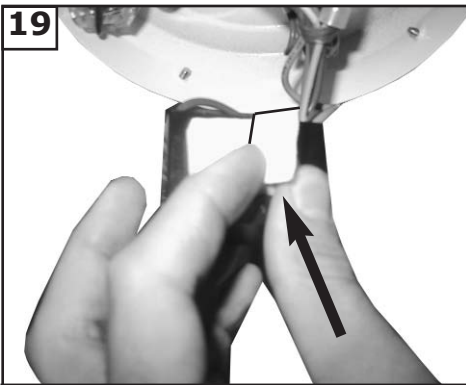

Remove twin adhesive tape from the black capacitor as shown above.

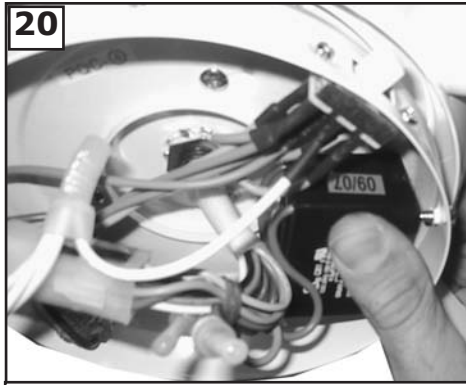

Place and press firmly on the capacitor to stick it to the switch housing. Be sure it is secure.

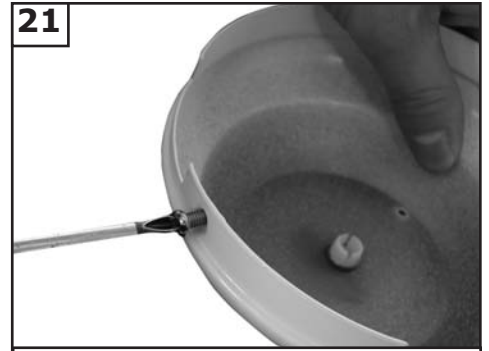

Remove the 3 screws from switch cap.



Install switch cap onto switch plate housing, align the 3 holes and install 3 screws and tighten securely.



Attach FOB with chain to chain from fan.

# Trouble Shooting

If you have difficulty operating your new ceiling fan, it may be the result of incorrect assembly, installation, or wiring. In some cases, these installation errors may be mistaken for defects. If you experience any faults, please check this Trouble Shooting Chart. If a problem cannot be remedied, or you are experiencing difficulty in installation, please call our Customer Service Center at the number printed on your parts list insert sheet.

**Warning: Before servicing or cleaning unit, Switch power off at Service panel and lock service disconnecting means to prevent power from being switched on accidentally. When the service disconnecting means cannot be locked, securely fasten a prominent warning device, such as a tag, to the service panel.**

| Trouble                    | Suggested Remedy  |
|----------------------------|---|
| 1. If fan does not start:  | <ol style="list-style-type: none"><li>1.Check main and branch circuit fuses or circuit breakers.</li><li>2.Check line wire connections to fan and switch wire connections in switch housing.</li><li>3.Make sure that any shipping stabilizer has been removed from motor.</li></ol> <p><b>CAUTION: Make sure main power is turned off.</b></p>   |
| 2. If fan sounds noisy:    | <ol style="list-style-type: none"><li>1.Check to make sure all screws in motor housing are snug (not over tightened).</li><li>2.Check to make sure the screws which attach the fan blade holder to the motor are tight.</li><li>3.Check to make sure wire nut connectors in switch housing are not rattling against each other or against the interior wall of the switch housing.</li></ol> <p><b>CAUTION: Make sure main power is turned off before entering switch housing.</b></p> <ol style="list-style-type: none"><li>4.Some fan motors are sensitive to signals from Solid State variable speed controls. <b>DO NOT USE a Solid State variable speed control.</b></li><li>5.Allow "break-in" period of 24 hours. Most noises associated with a new fan will disappear after this period.</li></ol>  |
| 3. If fan wobbles:         | <ol style="list-style-type: none"><li>1.Make sure that the ridge of the canopy engages the notch in the downrod ball.</li><li>2.Check that all blades are screwed firmly into blade holders.</li><li>3.Check that all blade holders are tightened securely to motor.</li><li>4.Make sure that canopy and mounting bracket are tightened securely to ceiling junction box and junction box is mounted firmly to ceiling joist.</li><li>5.Most fan wobble problems are caused when blade levels are unequal. Check this level by selecting a point on the ceiling above the tip of one of the blades. Measure this distance from blade tip to ceiling. Keeping measure within 1/8", rotate the fan until the next blade is positioned for measurement. Repeat for each blade. If all blade levels are not equal, you can adjust blade levels by the following procedure. To adjust a blade tip down, insert a washer (not supplied) between the blade and blade holder at the screw closest to the motor. To adjust a blade tip up, insert washer (not supplied) between the blade and blade holder at the two screws farthest from the motor. Reverse the position of the washer if blades mount from top of blade.</li><li>6.If blade wobble is still noticeable, interchanging two adjacent (side by side) blades can redistribute the weight and possibly result in smoother operation.</li></ol> |
| 4. If light does not work: | <ol style="list-style-type: none"><li>1.Check wire from fan to make sure it is connected to hot wire from house.</li><li>2.Check for loose or disconnected wires in fan switch housing.</li><li>3.Check for loose or disconnected wires in light kit.</li><li>4.Check for faulty light bulbs.</li></ol>   |

**MONTE CARLO**

Customer Service Center:  
1-800-519-4092