

Owner's Manual

Ceiling Fan Installation Instructions



For 5ALR56 Series Fans

READ AND SAVE THESE INSTRUCTIONS

Total fan weight with
light kit included

**MONTE
CARLO®**



Installation

SAFETY TIPS

WARNING: TO REDUCE THE RISK OF FIRE, ELECTRIC SHOCK, OR INJURY TO PERSONS, OBSERVE THE FOLLOWING: READ AND SAVE THESE INSTRUCTIONS

1. Installation work and electrical wiring must be done by qualified person(s) in accordance with applicable codes and standards (ANSI/NFPA 70-1999), including fire-rated construction.
2. Use this unit only in the manner intended by the manufacturer. If you have any questions contact the manufacturer.
3. After making the wire connections, the wires should be spread apart with the grounded conductor and the equipment-grounding conductor on one side of the outlet box and ungrounded conductor on the other side of the outlet box.
4. Before you begin installing the fan, Switch power off at Service panel and lock service disconnecting means to prevent power from being switched on accidentally. When the service disconnecting means cannot be locked, securely fasten a prominent warning device, such as a tag, to the service panel.
5. Be cautious! read all instructions and safety information before installing your new fan. Review the accompanying assembly diagrams.
6. When cutting or drilling into wall or ceiling, do not damage electrical wiring and other hidden utilities.
7. Make sure the installation site you choose allows the fan blades to rotate without any obstructions. Allow a minimum clearance of 7 feet from the floor to the trailing edge of the blade.
8. **WARNING** – Risk of fire, electric shock, or personal injury, The fan in this box may be either directly supported from a structural framing member of a building and/or may be mounted to an outlet box marked acceptable for fan support of 31.8 kg. (70 lbs.) or less. Most outlet boxes commonly used for the support of luminaires may not be acceptable for fan support and may need to be replaced. Consult a qualified electrician if in doubt.
9. Do not bend blade holders during installation to motor, balancing or during cleaning. Do not insert foreign object between rotating blades.
10. Attach the mounting bracket using only the hardware supplied with the outlet box.
11. To reduce the risk of fire or electric shock, do not use this fan with any solid state fan speed control device, or variable speed control.
12. If this unit is to be installed over a tub or shower, it must be marked as appropriate for the application.
13. **NEVER** place a switch where it can be reached from a tub or shower.
14. The combustion airflow needed for safe operation of fuel-burning equipment may be affected by this unit's operation. Follow the heating equipment manufacturer's guideline safety standards such as those published by the National Fire Protection Association (NFPA), and the American Society for Heating, Refrigeration and Air Conditioning Engineers (ASHRAE) and the local code authorities.
15. Before servicing or cleaning unit, Switch power off at Service panel and lock service disconnecting means to prevent power from being switched on accidentally. When the service disconnecting means cannot be locked, securely fasten a prominent warning device, such as a tag, to the service panel.

TOOLS REQUIRED

PhillipsScrewdriver

Wire Cutters

PliersStep

Ladder

1



Before you begin installing the fan, Switch power off at Service panel and lock service disconnecting means to prevent power from being switched on accidentally. When the service disconnecting means cannot be locked, securely fasten a prominent warning device, such as a tag, to the service panel.

2

OUTLET BOX METHOD

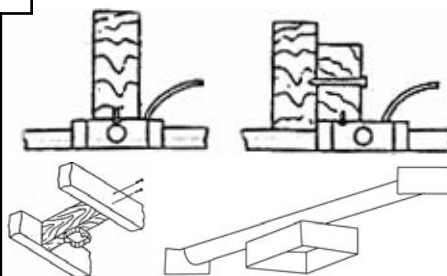

Warning-Risk of fire, electric shock, or personal injury. The fan in this box may be either directly supported from a structural framing member of a building and/or may be mounted to an outlet box marked acceptable for fan support of 31.8 kg(70lbs) or less. Most outlet boxes commonly used for the support of luminaires may not be acceptable for fan support and may need to be replaced. Consult a qualified electrician if in doubt.

3



Remove Safety bar from mounting bracket by loosening screws, sliding bar to side, and lifting it off the 2 screws.

4



Remove the 4 screws attaching the Mounting neck the mounting plate. Retain the 4 screws for re-assembly.

5

BUILDING STRUCTURE METHOD

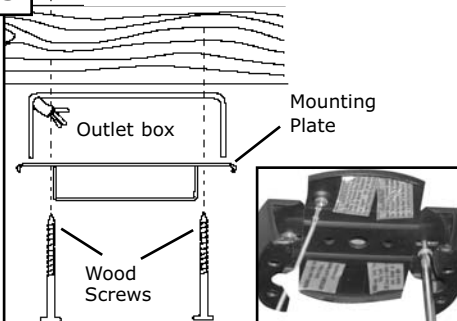

Secure mounting plate directly to a joist from the building structure via the two knock out holes on the outlet box. Use only the appropriate wood screws and washers included with your fan. Caution: Wood screws must go through into the building joist.

6

FAN BRACE AND BOX METHOD



Install the mounting Plate to approved fan brace and box combination use only the hardware provided with the fan brace and box.

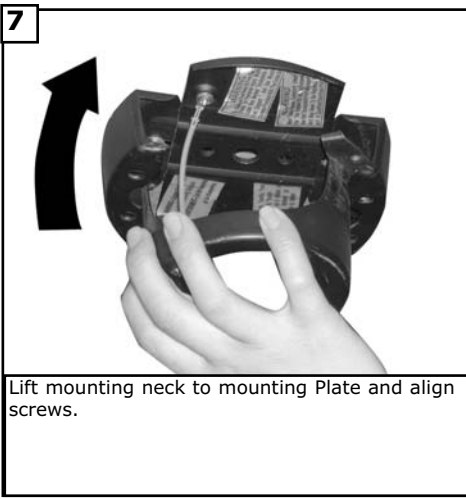

Lift mounting neck to mounting Plate and align screws.

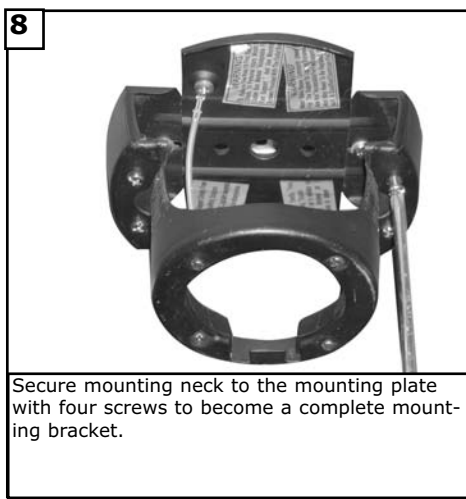

Secure mounting neck to the mounting plate with four screws to become a complete mounting bracket.

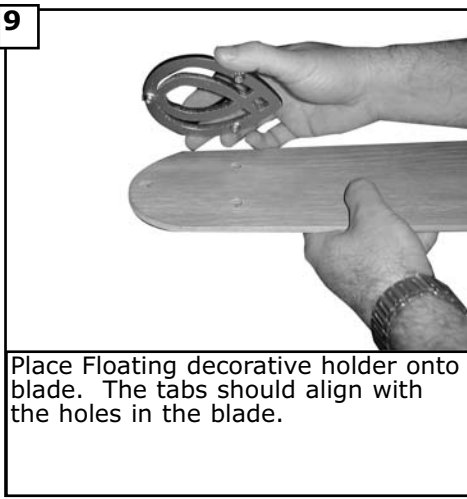

Place Floating decorative holder onto blade. The tabs should align with the holes in the blade.

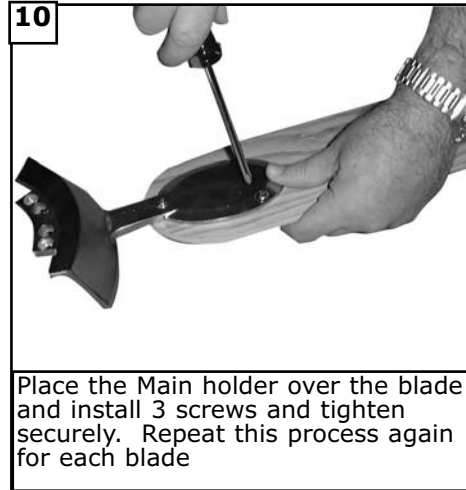

Place the Main holder over the blade and install 3 screws and tighten securely. Repeat this process again for each blade



Install Blade / blade holder assembly to fan motor using large motor screws. Repeat this process 4 more times until all blades are installed to the fan.

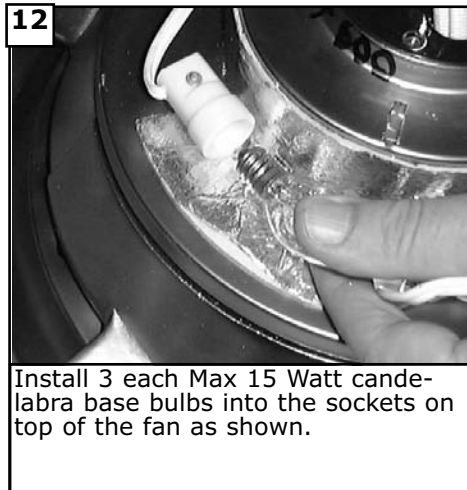

Install 3 each Max 15 Watt candleabra base bulbs into the sockets on top of the fan as shown.

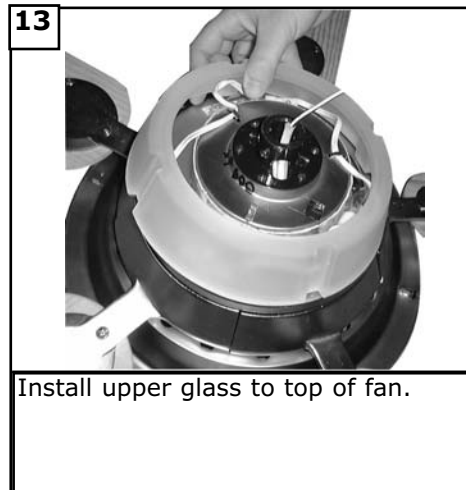

Install upper glass to top of fan.

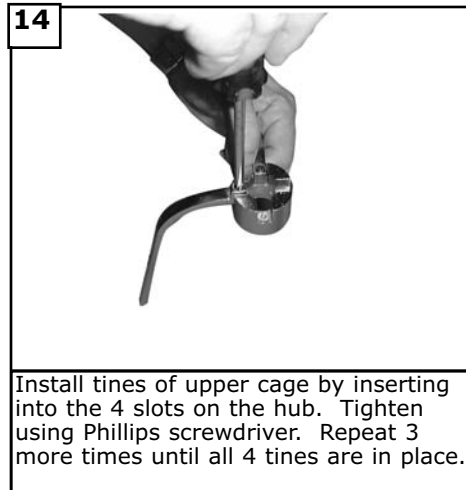

Install tines of upper cage by inserting into the 4 slots on the hub. Tighten using Phillips screwdriver. Repeat 3 more times until all 4 tines are in place.

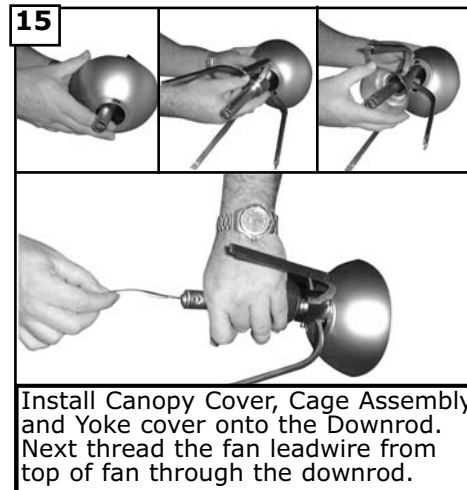

Install Canopy Cover, Cage Assembly and Yoke cover onto the Downrod. Next thread the fan leadwire from top of fan through the downrod.

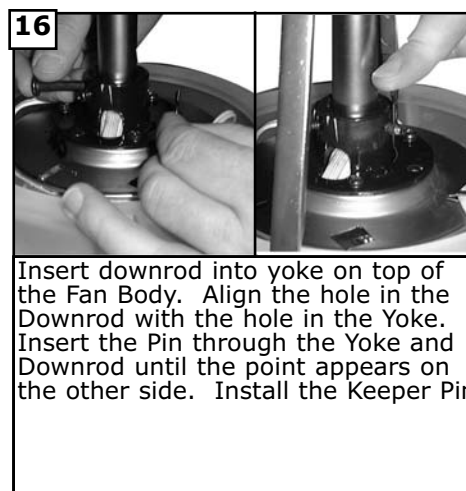

Insert downrod into yoke on top of the Fan Body. Align the hole in the Downrod with the hole in the Yoke. Insert the Pin through the Yoke and Downrod until the point appears on the other side. Install the Keeper Pin

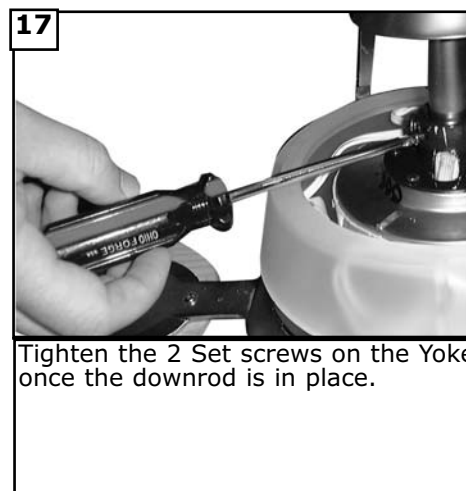

Tighten the 2 Set screws on the Yoke once the downrod is in place.

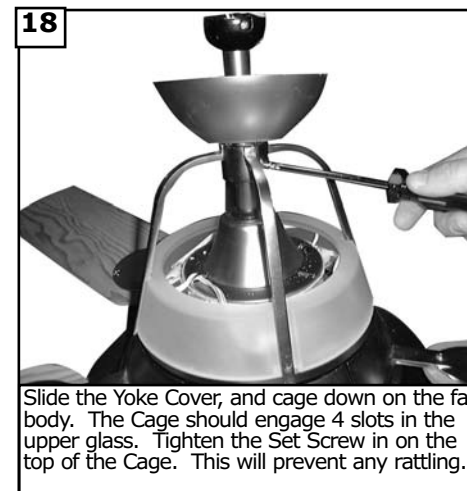

Slide the Yoke Cover, and cage down on the fan body. The Cage should engage 4 slots in the upper glass. Tighten the Set Screw in on the top of the Cage. This will prevent any rattling.

19

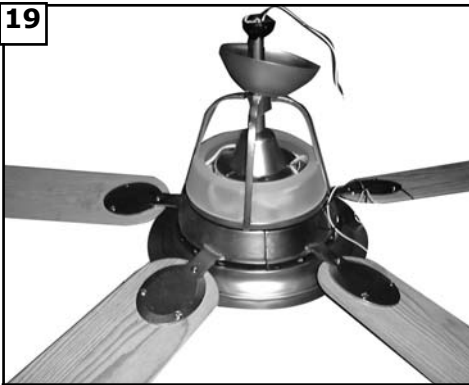

Your fan should look like this. You are now ready to hang the fan

20



Hang assembled fan from the mounting bracket installed to ceiling in previous step. Make sure the fan is hanging straight. Rotate fan until the tab on the Mounting bracket engages the slot on the Downrod Ball. This must be done to prevent the fan body from rotating when the blades are in motion.

21

Safety cable installation

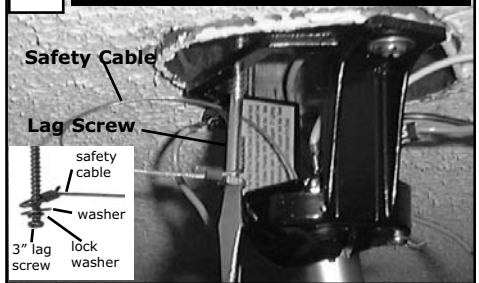

For Canadian installation and for USA fan and light kit combinations over 35 lbs, in both flush and downrod mode the safety cable must be installed into the house structure beams using the 3" lag screws, washers, and lock washers provided. Make sure that when the safety cable is fully extended the leadwires are longer than the cable and no stress is placed on the leadwires.

22

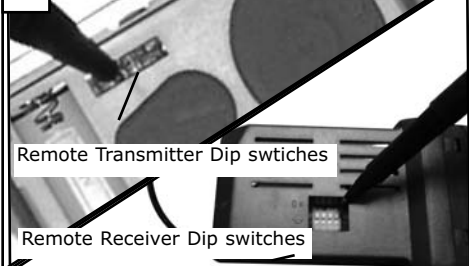

Remote Transmitter Dip switches

Remote Receiver Dip switches

Set dip switches on the Remote Transmitter and Remote Receiver to the same settings. This must be done so the units will communicate properly. If you have other fans you can set to control from one transmitter by setting both receivers the same as the transmitter. If you have more than one fan with remote. You can set the dip switches to different positions to have separate control.

23



Install remote receiver by sliding into opening in the Mounting bracket. Make sure that the dip switches on the Transmitter and the Receiver are set to the same position.

24

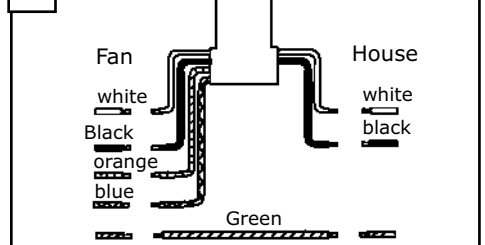

Make wiring connections as indicated above. White from fan to white from remote marked N. Orange from fan to Orange from remote marked Light/up. Blue from fan to blue from remote marked down light. Black from fan to Black from remote marked L. White from house to white from remote marked AC N. Black from house to Black from remote marked AC L. Connect all green ground wires to Ground wire from House.

25



Re-install safety bar removed in step 3 by placing safety bar on screws, sliding into place, and tightening the 2 screws.

26



Make wire connections to power source using wire nuts provided. Make sure that no filaments are outside of the wirenut. After making the wire connections, the wires should be spread apart with the grounded conductor and the equipment-grounding conductor on one side of the outlet box and ungrounded conductor on the other side of the outlet box.

27



Lift Canopy to ceiling aligning the key hole slots with the screws on the bottom of the Mounting bracket. Rotate the canopy Counter Clockwise to lock in place. Tighten the screws to secure the Canopy. See inset for Keyhole shape

28



Install 2X 50 watt E-11 halogen base bulbs. Bulbs included.

29



Loosen screws in on the glass cage. this will allow the screws to fit into the Keyhole slots on the fan housing

30



Lift Glass and lower cage to the fan body. Align the 4 screws on the cage with 4 keyhole slots in fan body (See Inset for keyhole shape). Rotate the glass and cage counter clockwise to lock into place.

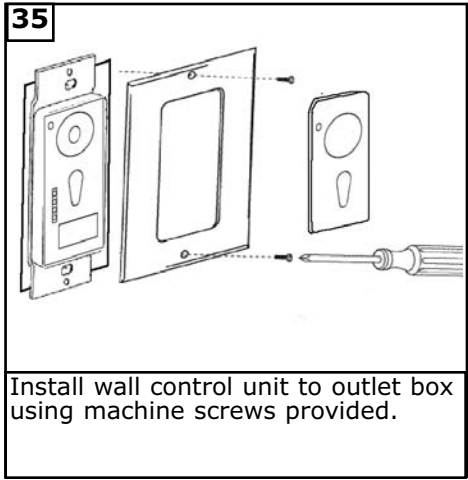
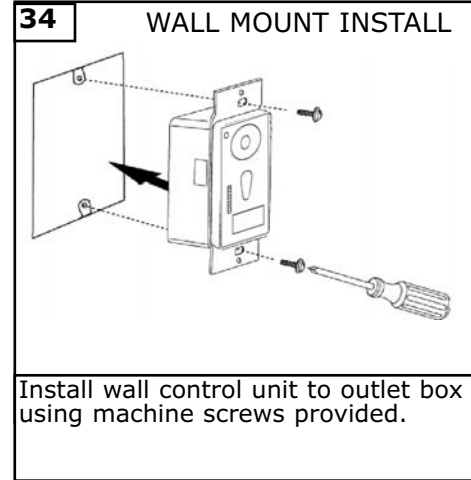
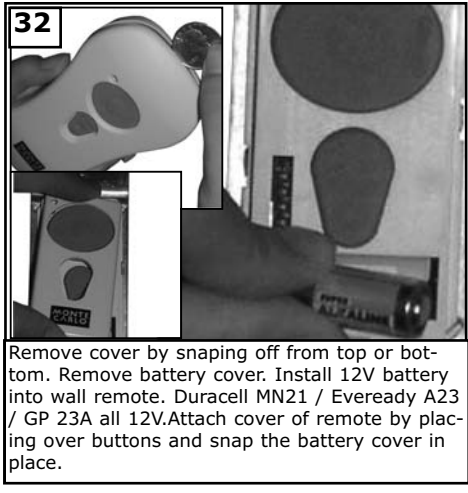
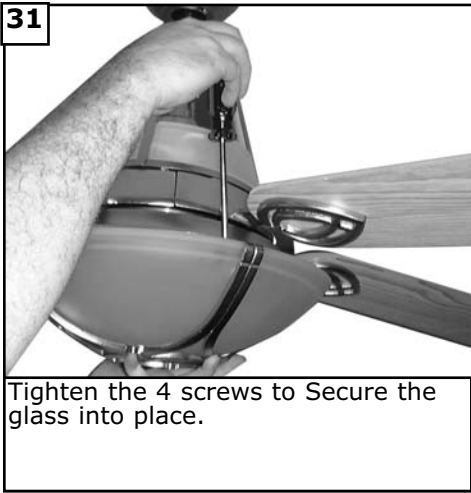

MONTE CARLO

Remote Control Transmitter Features:

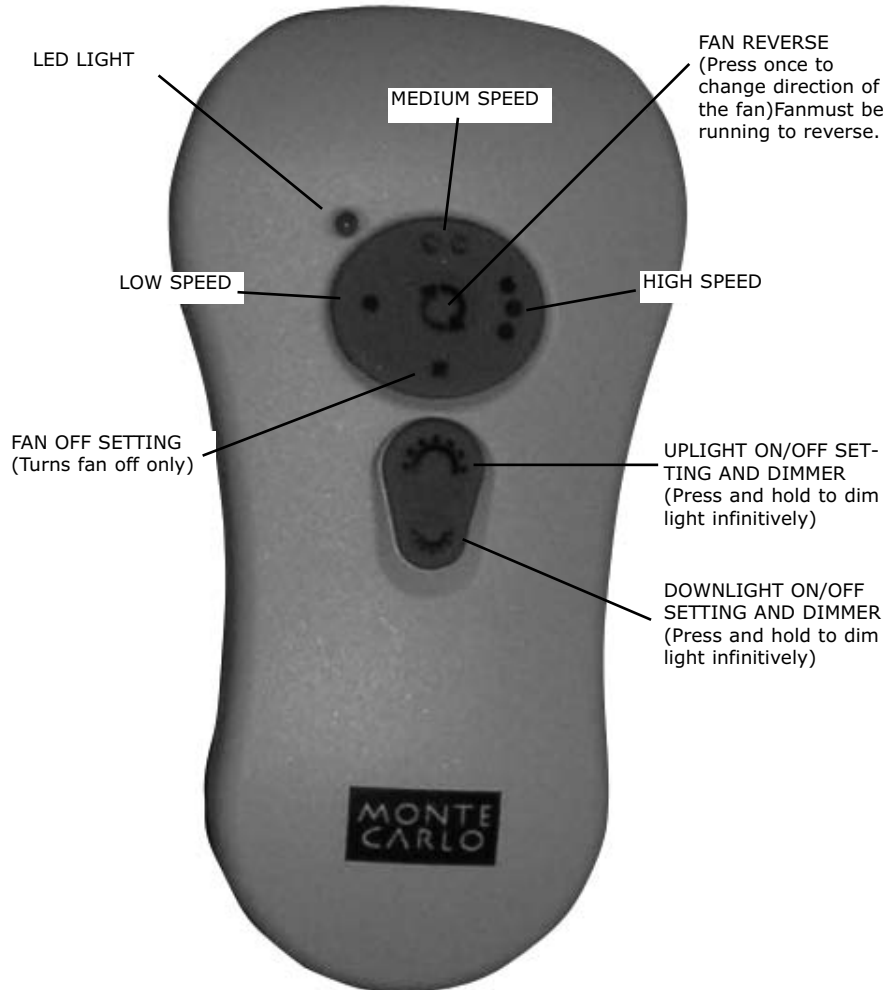

FAN SPEED Depress "1 dot" for low speed, "2 dots" for medium or "3 dots" for high. To turn fan off press square".

LIGHT DIMMER To turn light on, press light dimmer once quickly. To turn off press once quickly while light is on. To dim light hold down button "light dimmer". The light will cycle from bright to dim to bright until button is released. Light will maintain last setting if turned off.

FORWARD/REVERSE Depress rev button allow a few seconds for remote to change rotation direction with fan running.

Trouble Shooting

If you have difficulty operating your new ceiling fan, it may be the result of incorrect assembly, installation, or wiring. In some cases, these installation errors may be mistaken for defects. If you experience any faults, please check this Trouble Shooting Chart. If a problem cannot be remedied, or you are experiencing difficulty in installation, please call our Customer Service Center at the number printed on your parts list insert sheet.

Warning: Before servicing or cleaning unit, Switch power off at Service panel and lock service disconnecting means to prevent power from being switched on accidentally. When the service disconnecting means cannot be locked, securely fasten a prominent warning device, such as a tag, to the service panel.

1. If fan does not start:
1. Check main and branch circuit fuses or circuit breakers.
 2. Check line wire connections to fan and switch wire connections in switch housing.
 3. Check to make sure the dip switches from the transmitter and receiver are set on the same frequency.

CAUTION: Make sure main power is turned off.

2. If fan sounds noisy:
1. Check to make sure all screws in motor housing are snug (not over tightened).
 2. Check to make sure the screws which attach the fan blade holder to the motor are tight.

CAUTION: Make sure main power is turned off before entering switch housing.

3. Allow "break-in" period of 24 hours. Most noises associated with a new fan will disappear after this period.

3. If fan wobbles:
1. Make sure that the ridge of the canopy engages the notch in the downrod ball.
 2. Check that all blades are screwed firmly into blade holders.
 3. Check that all blade holders are tightened securely to motor.
 4. Make sure that canopy and mounting bracket are tightened securely to ceiling junction box and junction box is mounted firmly to ceiling joist.
 5. Most fan wobble problems are caused when blade levels are unequal. Check this level by selecting a point on the ceiling above the tip of one of the blades. Measure the distance from blade to ceiling. Keeping measure within 1/8", rotate the fan until the next blade is positioned for measurement. Repeat for each blade. If all blade levels are not equal, you can adjust blade levels by the following procedure. To adjust a blade tip down, insert a washer (not supplied) between the blade and blade holder at the screw closest to the motor. To adjust a blade tip up, insert washer (not supplied) between the blade and blade holder at the two screws farthest from the motor. Reverse the position of the washer if blades mount from top of blade.
 6. If blade wobble is still noticeable, interchanging two adjacent (side by side) blades can redistribute the weight and possibly result in smoother operation.

4. If light does not work:
1. Check blue wire from fan to make sure it is connected to hot wire from house.
 2. Check for loose or disconnected wires in fan switch housing.
 3. Check for loose or disconnected wires in light kit.
 4. Check for faulty light bulbs.

CAUTION: Make sure main power is turned off before entering switch housing.

MONTE CARLO

Customer Service Center:
301 West Washington St.
Riverside, NJ 08075
1-800-519-4092
www.montecarlofans.com